



# AT-BBLF-0067-1815C

## 90kHz-67GHz Broadband Amplifier

### 90kHz-67GHz Optical Modulator Driver

2022-7-11



#### Product Overview

AT-BBLF-0067-1815C is broadband amplifier from 90kHz-67GHz, with  $P_{out}=+15dBm$ ,  $NF=6dB$ . It can be used both as Power amplifier or low noise amplifier. The DC power requirement is +8V/220mA. The module is with 1.85mm Female Input port and Male output port.

The broadband amplifier has high gain, high linearity, low input/output return loss and flat gain response.

More information, please visit [www.atmicrowave.com](http://www.atmicrowave.com)

#### Advantages

- ✓ Frequency: 90kHz-67GHz
- ✓  $P_{sat}=+15dBm$
- ✓ Small signal gain: 18dB
- ✓ Single Power Supply

#### Application

- ✓ Optical Modulator Driver
- ✓ 5G Communication
- ✓ Test Equipment
- ✓ ROF (RF Over Fiber)

#### Mechanical Information

Item	Description
Input Port	1.85mm Female
Output Port	1.85mm Male
Case Material	Copper
Finish	Gold Plated
Package Sealing	Epoxy Sealed
Weight (Without Heatsink)	80g
Size:	100x30x9.5mm





# AT-BBLF-0067-1815C

## 90kHz-67GHz Broadband Amplifier

### Key Features

Parameter	Min	Typical	Max
Lower Frequency		90kHz	
Upper Frequency	65GHz	67GHz	
Small Signal Gain	16dB	18dB	
P1dB		10MHz-50GHz: +15dBm, 3.56Vpp 50GHz-67GHz: +12dBm, 2.52Vpp	
Psat		10MHz-50GHz: +17dBm, 4.48Vpp 50GHz-67GHz: +13dBm, 2.83Vpp	
Drain Supply		+8V	+12V
Current		250 mA	
NF(1-50GHz)		6dB	
Input Return Loss		-10dB	
Output Return Loss		-5dB	
Spec Temp		25C	

### Absolute Maximum Ratings Table

Parameter	Value
Drain Supply	+13V
RF Input Power	+4 dBm
Input Voltage	1Vpp
Operating Temperature	-20 to +70C
Storage Temperature	-65 to +125C

#### Caution:

Please pay attention to the case temperature. If case temperature exceed higher than +100C, heat sink and fan are required, or the amplifier may be damaged.

### Notes:

1. Datasheet may be changed according to update of MMIC, Raw materials , process, and so on.
2. This data is only for reference, not for guaranteed specifications.
3. Please contact AT Microwave team to make sure you have the most current data.



### Test Data

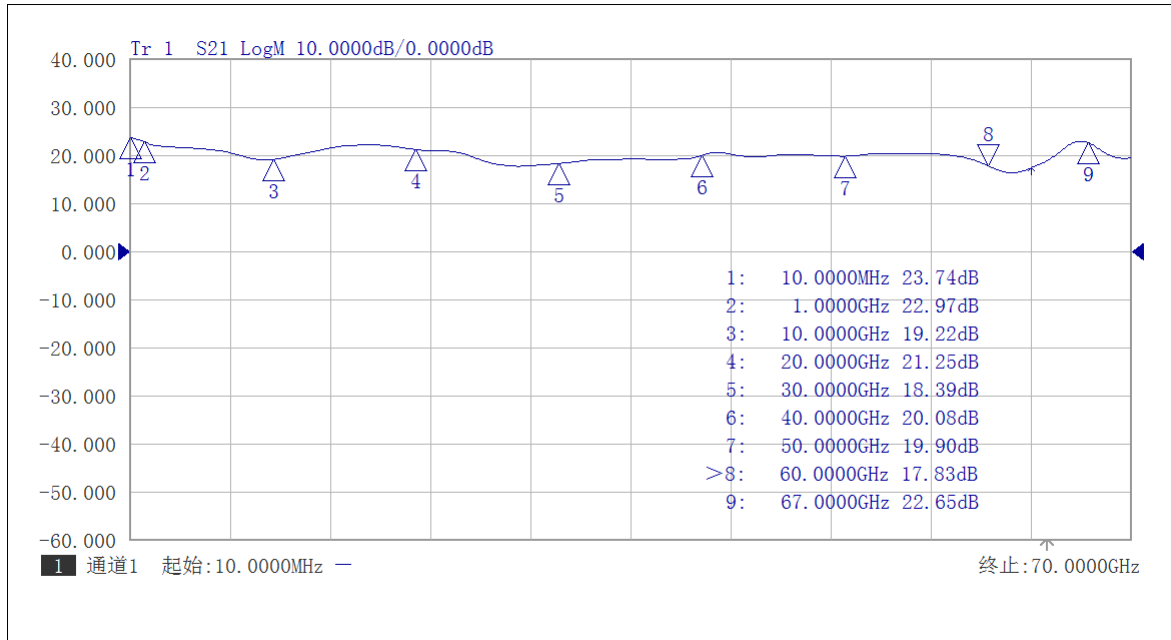

Gain vs Frequency 10MHz-67GHz

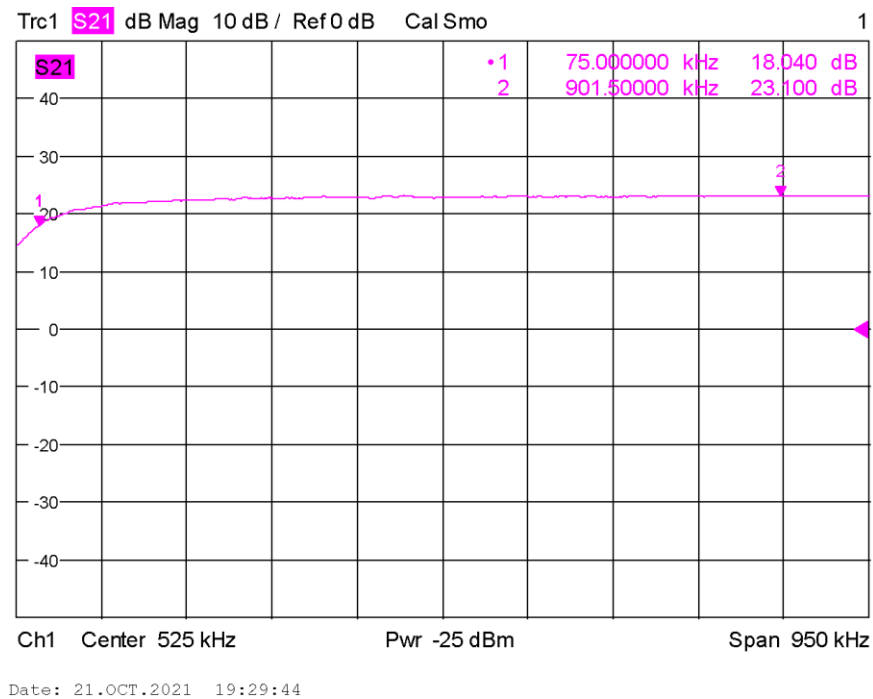

Gain vs Frequency 90kHz-1MHz



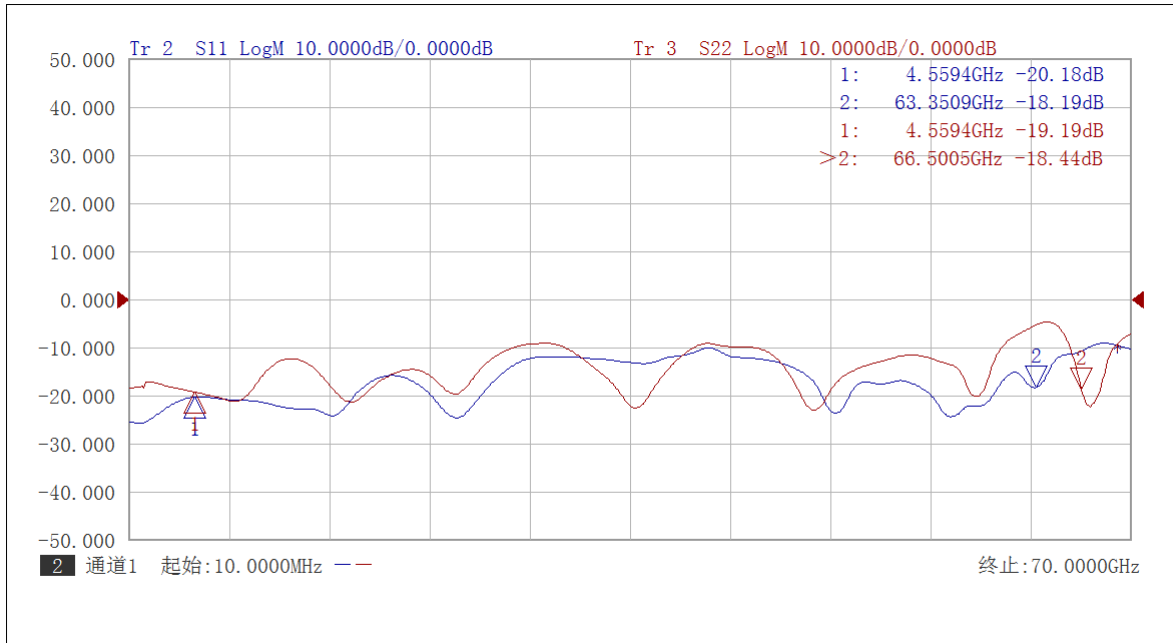

S11/S22 Return Loss vs Frequency 10MHz-67GHz

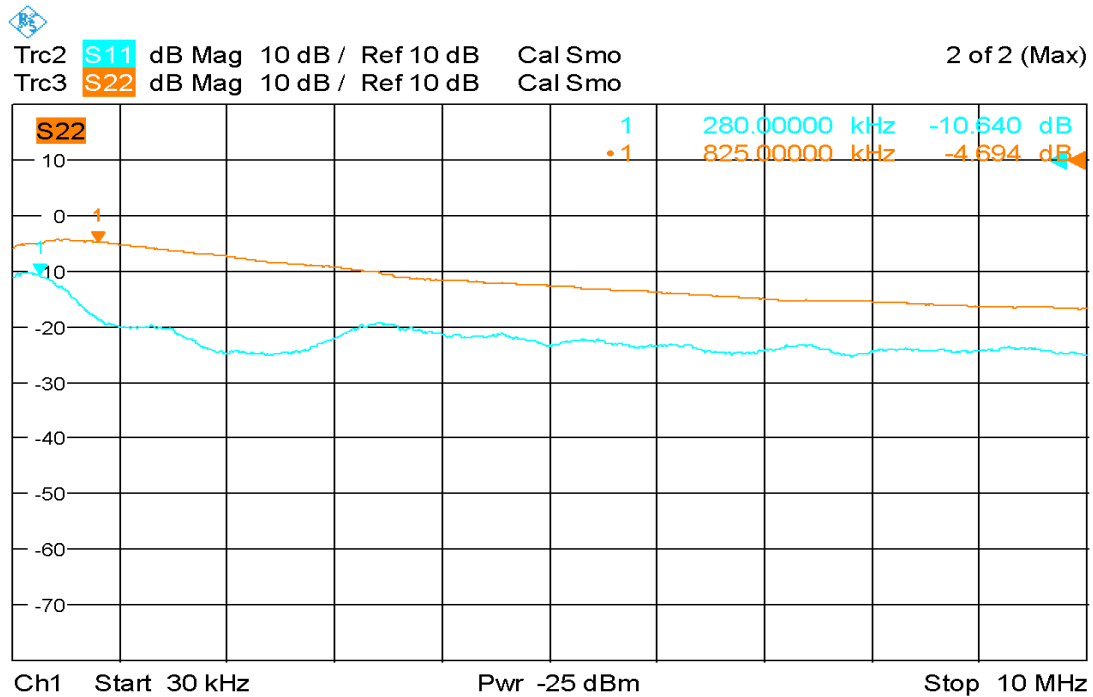

Date: 18.MAY.2021 18:25:50

S11/S22 Return Loss vs Frequency 50kHz-10MHz



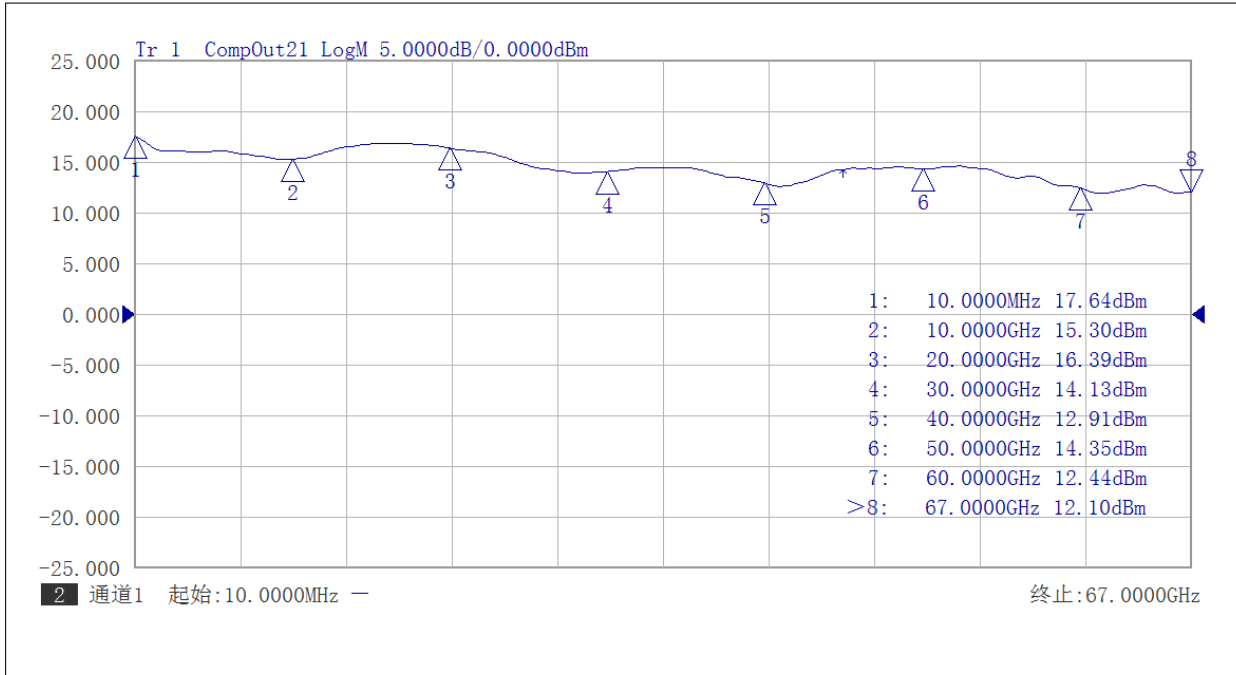

P1dB Test 10MHz-67GHz

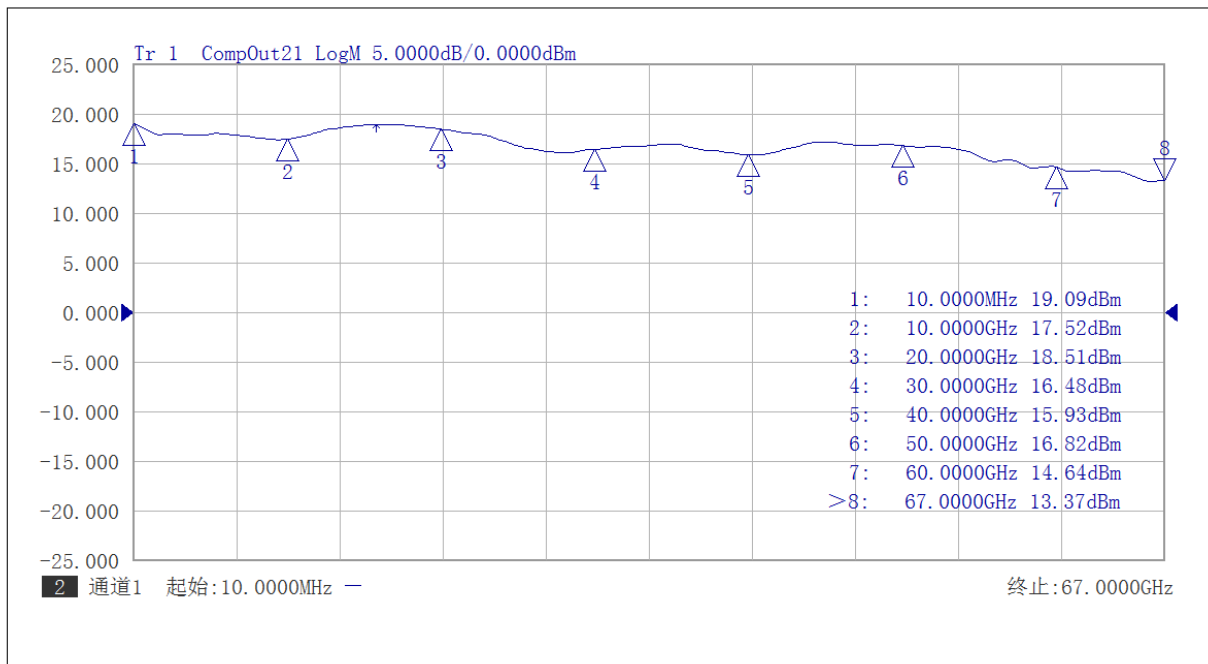

P3dB test 10MHz-67GHz



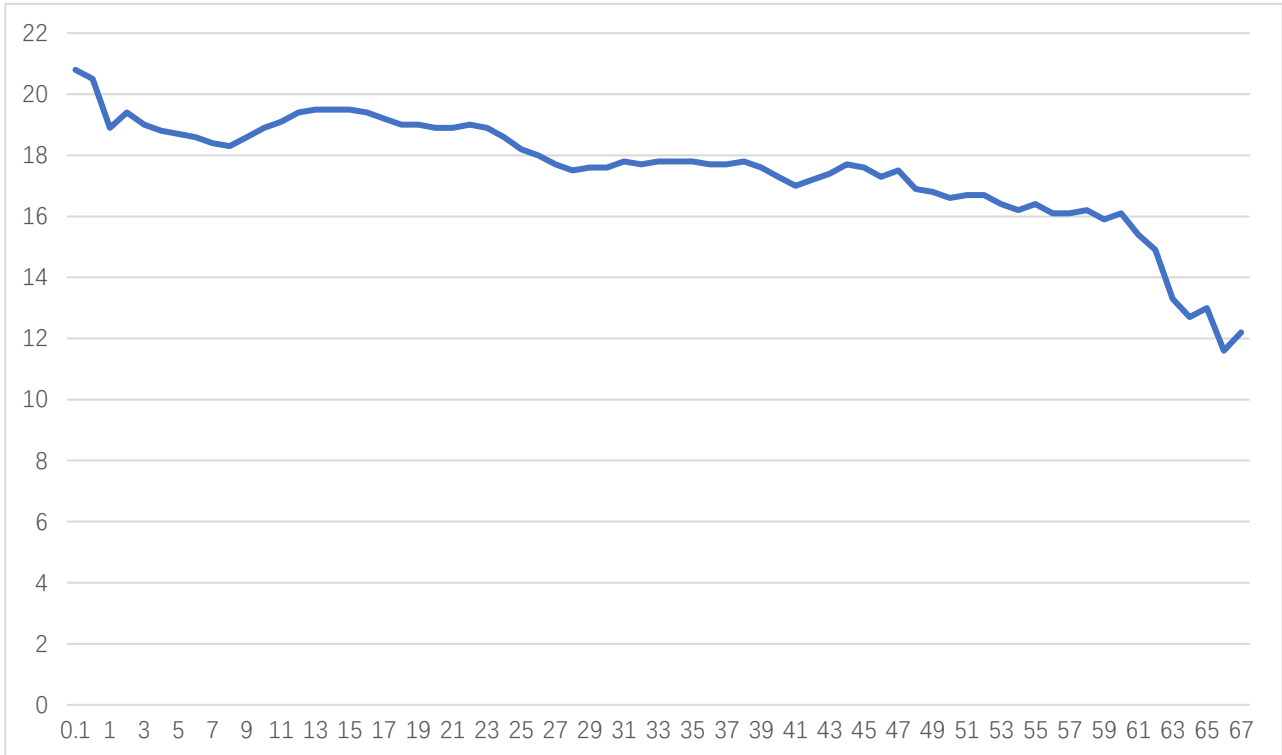

Psat vs Frequency 10MHz-67GHz

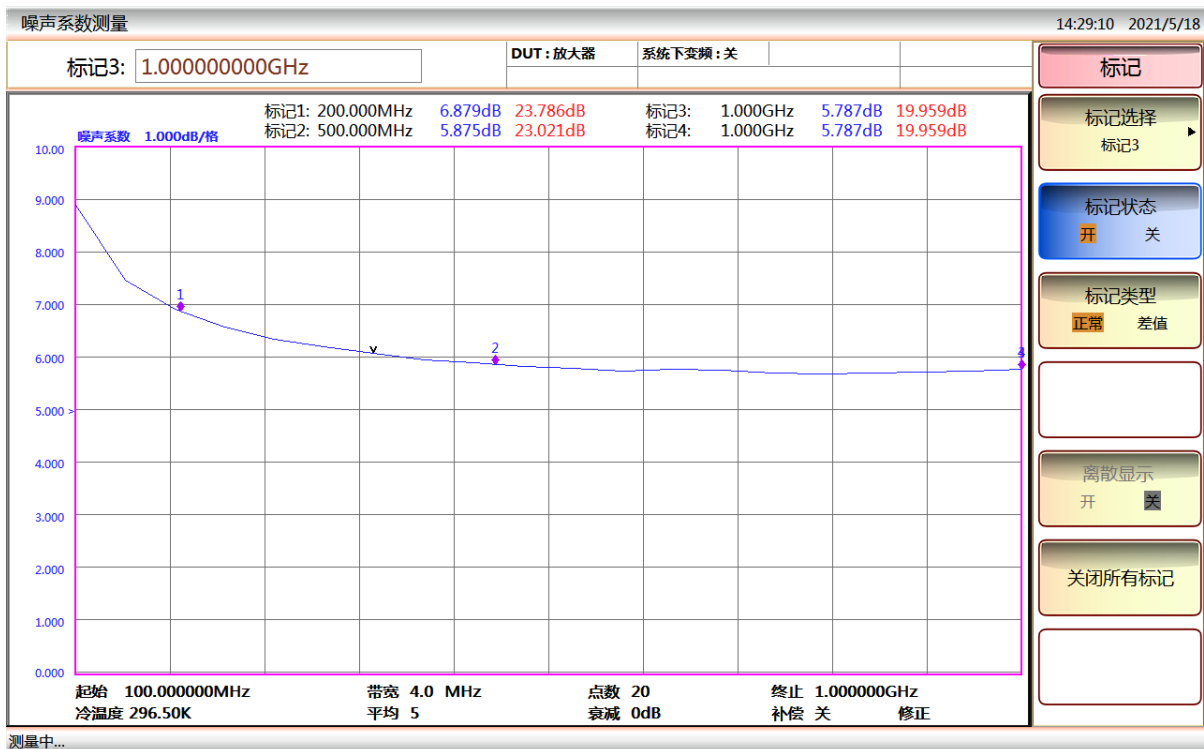

NF test from 10MHz to 1GHz



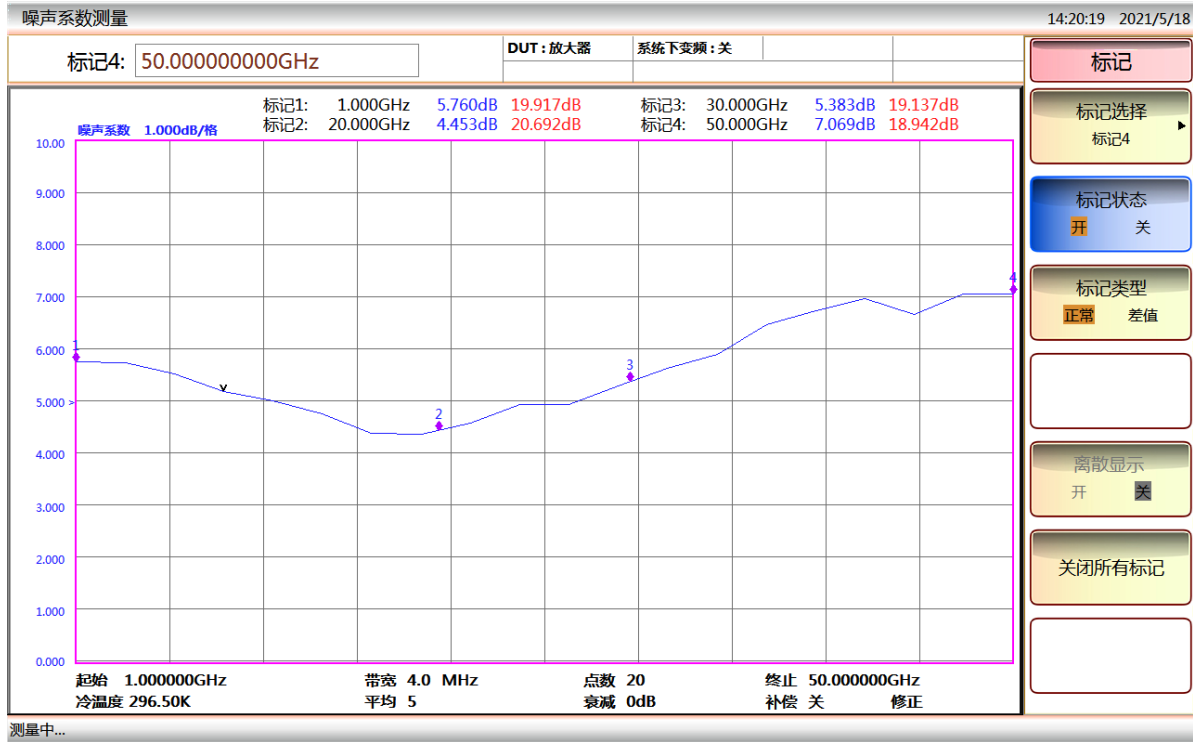

NF test From 1-50GHz

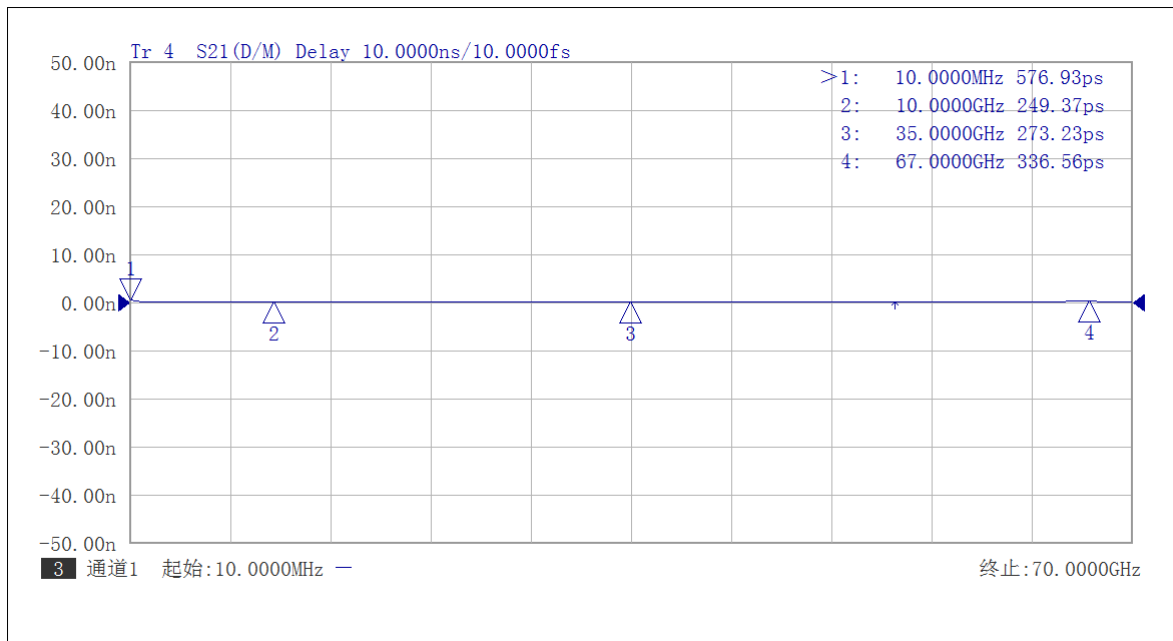

Group delay vs Frequency



**Dimension:** (unit in mm)

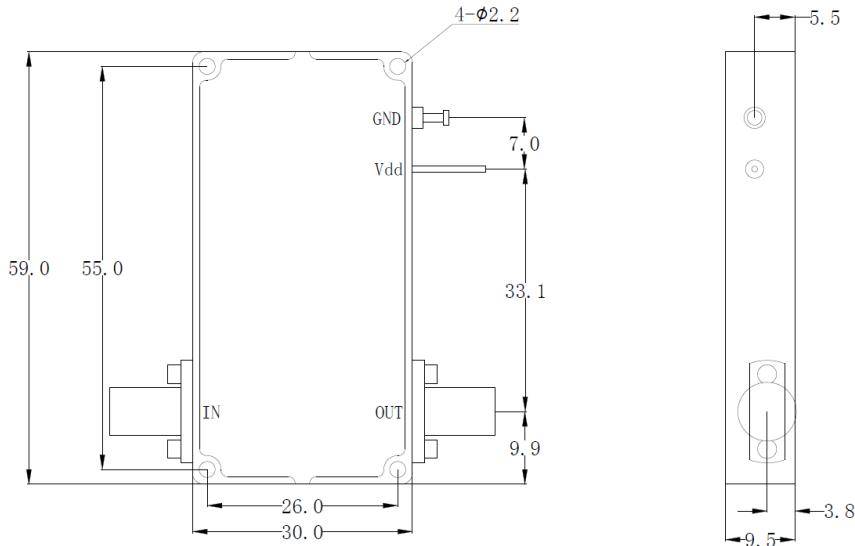

	<26.5GHz	<40GHz	<50GHz	<67GHz
Connector	SMA	2.92mm	2.4mm	1.85mm
Lenth of a	9.4mm	9.5mm	10.8mm	11.3mm

Note: Female Default. Contact with us for other types.

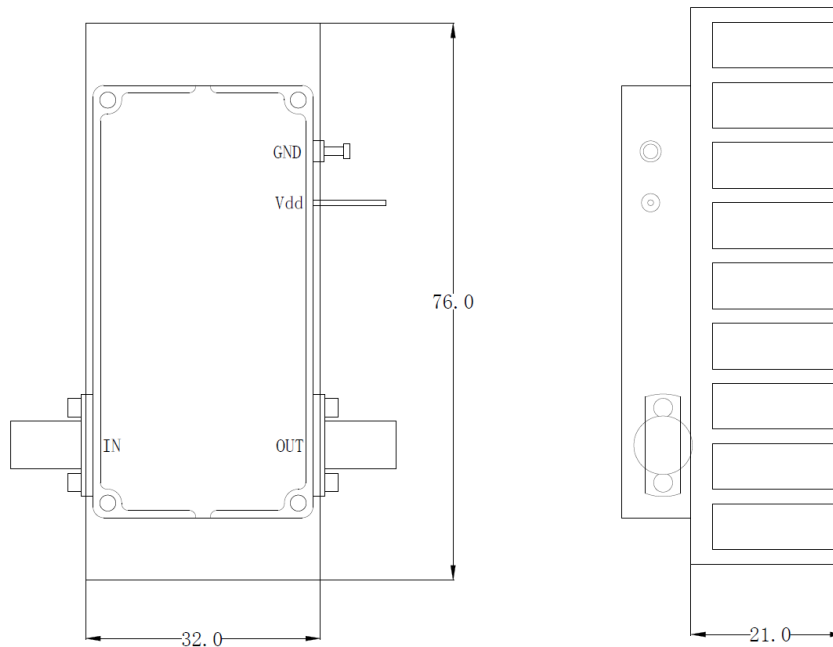

Including a small heatsink without Fan if output Power higher than +20dBm.  
Customers can remove it or use their own heatsink according to actual situation.

**Heatsink required during Operation**







# AT-BBLF-0067-1815C

90kHz-67GHz Broadband Amplifier

## Vpp vs dBm at 50 Ohms System

dBm	Vpp	Vrms	Power ( W )	dBm	Vpp	Vrms	Power ( W )
50	200.00	70.71	100.00	14	3.17	1.12	2.51E-02
49	178.25	63.02	79.43	13	2.83	1.00	2.00E-02
48	158.87	56.17	63.10	12	2.52	0.89	1.58E-02
47	141.59	50.06	50.12	11	2.24	0.79	1.26E-02
46	126.19	44.62	39.81	10	2.00	0.71	1.00E-02
45	112.47	39.76	31.62	9	1.78	0.63	7.94E-03
44	100.24	35.44	25.12	8	1.59	0.56	6.31E-03
43	89.34	31.59	19.95	7	1.42	0.50	5.01E-03
42	79.62	28.15	15.85	6	1.26	0.45	3.98E-03
41	70.96	25.09	12.59	5	1.12	0.40	3.16E-03
40	63.25	22.36	10.00	4	1.00	0.35	2.51E-03
39	56.37	19.93	7.94	3	0.89	0.32	2.00E-03
38	50.24	17.76	6.31	2	0.80	0.28	1.58E-03
37	44.77	15.83	5.01	1	0.71	0.25	1.26E-03
36	39.91	14.11	3.98	0	0.63	0.22	1.00E-03
35	35.57	12.57	3.16	-1	0.56	0.20	7.94E-04
34	31.70	11.21	2.51	-2	0.50	0.18	6.31E-04
33	28.25	9.99	2.00	-3	0.45	0.16	5.01E-04
32	25.18	8.90	1.58	-4	0.40	0.14	3.98E-04
31	22.44	7.93	1.26	-5	0.36	0.13	3.16E-04
30	20.00	7.07	1.00	-6	0.32	0.11	2.51E-04
29	17.83	6.30	0.79	-7	0.28	9.99E-02	2.00E-04
28	15.89	5.62	0.63	-8	0.25	8.90E-02	1.58E-04
27	14.16	5.01	0.50	-9	0.22	7.93E-02	1.26E-04
26	12.62	4.46	0.40	-10	0.20	7.07E-02	1.00E-04
25	11.25	3.98	0.32	-11	0.18	6.30E-02	7.94E-05
24	10.02	3.54	0.25	-12	0.16	5.62E-02	6.31E-05
23	8.93	3.16	0.20	-13	0.14	5.01E-02	5.01E-05
22	7.96	2.82	0.16	-14	0.13	4.46E-02	3.98E-05
21	7.10	2.51	0.13	-15	0.11	3.98E-02	3.16E-05
20	6.32	2.24	0.10	-16	0.10	3.54E-02	2.51E-05
19	5.64	1.99	7.94E-02	-17	8.93E-02	3.16E-02	2.00E-05
18	5.02	1.78	6.31E-02	-18	7.96E-02	2.82E-02	1.58E-05
17	4.48	1.58	5.01E-02	-19	7.10E-02	2.51E-02	1.26E-05
16	3.99	1.41	3.98E-02	-20	6.32E-02	2.24E-02	1.00E-05
15	3.56	1.26	3.16E-02	-21	5.64E-02	1.99E-02	7.94E-06

